



SPEED GATE TURNSTILE

HG - 300 - S | HG - 300 - C

SERIES

Your gate to protection...

The HG-300 Series are durable products for indoor use and provide access and access control in areas requiring lower and medium security. With its compact housing design, it offers the perfect solution for assembly areas where aesthetics and elegance are important.

Barrier arm movement is provided by the Brushless DC motor with PLC control. Seven optical sensors in the turnstile provide control of access control scenarios. Speed Gate Turnstiles are suitable for intensive use. It is the perfect solution when architectural design, aesthetics and transition speed are important.

Design

- ▶ The main body of the turnstile is made of 304 stainless steel and the wings are made of tempered glass.
- ▶ Stain case design with smoothened corner.
- ▶ All other parts in turnstile are electro-galvanized against corrosion.

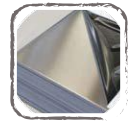

Safety

- ▶ Obstacle movement of the wings is provided by PLC controlled "Brushless DC Motor".
- ▶ Heavy duty mechanics, controlled by reliable electronics ensure a long product life with minimum maintenance requirement.



Integration

- ▶ Easy integration with all access control equipment through functional electronic control board (For example: RFID Device, Button Control, Finger Print and Biometric Device)



HG - 300 - S



Single Wing

- ▶ Turnstile main body is 304 stainless steel.
- ▶ It provides 550mm wide passage with standard wing.
- ▶ The top cover is made of black glass with 10mm tamper.

HG - 300 - C







Double Wing

- ▶ Turnstile main body is 304 stainless steel.
- ▶ It provides two 550 mm wide transition areas with corresponding standard wings.
- ▶ The top cover is made of black glass with 10mm tamper.





Technical Specifications









Main Body

| | | |
|-----------------------------------|--|---|
| Material | AISI- 304 - Stainless Steel - Scotch Brite |  |
| Standard Dimensions (W x L x H) | 30 x 145 x 97 cm | |
| Wings | 12 mm tempered glass (Opt. Logo Printing) |  |
| Standard Passageway Width | 550 mm (Passage Area : 225 mm + 100 mm + 225 mm) |  |
| Top Cover | 10 mm tempered glass (Upper surface of plexiglass) |  |

Electrical Parameters

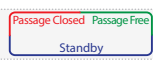





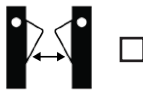











| | | |
|--------------------------------------|----------------------------------|---|
| Operating Voltage | 110 - 240V AC 50/60 Hz (+/- %10) |  |
| Nominal / Max Current | 300 mA / 1500 mA | |
| Power Consumption | 100 W |  |
| Mean Cycles Between Failure (MCBF) | 15 M Cycles | 100 W |

Function Working

| | | |
|-------------------------|---|---|
| Control Systems | All inputs are opto-coupler protected. Controlled by dry contact or grounding input. Compatible with all access control systems that provide dry contact or grounding outputs |  |
| Output Data (Feedback) | The systems provides dry contact, NO - Normally Open, entry - exit passage feedback by relays | |
| Movement Mechanism | Brushless DC Motor |  |
| Gate Open / Close Rate | 1 second | |
| Electronic Control Unit | PLC control unit |  |
| Time out Delay | Adjustable ; Operating Modes (7 - 14 - 21 second) | |
| Flow Rate | 30 Person - Passage / Minutes / Normally Standard* <small>(*The use of different access control units may result in a change in the transition speed.)</small> |  |
| Working Environment | Indoor | |
| Side Led Stripes | Passage Free - Green / Passage Closed - Red / Standby - Blue |  |
| Communication | RS 232 (Need PC Systems hardware serial port) |  |
| Operating Temperature | -20° C / + 68° C |  |
| Operating Humidity | 0 / + 45° C (RH 95% not-condensing) | |
| IP Rating | 44 |  |
| Passage Direction | Bi-Directional operation feature. Entrance-Exit | |

| | | |
|-------------------------|--|---|
| Number of Passage Lanes | Single Unit  | Double Unit  |
| Wing Movement | Wings Retracting into Body Fan Movement System  | Wings Retracting into Body Linear Movement System  |

Access Specifications

| | | | | | | | | | | | | | | | | |
|--------|---|---|---|---|---|---|---|---|---|---|---|--|---|---|---|---|
| 550 mm |  |  |  |  |  |  |  |  |  |  |  |  |  |  |  | <ul style="list-style-type: none">  Passage Available  Passage have some Limitations  Passage Not Available |
|--------|---|---|---|---|---|---|---|---|---|---|---|--|---|---|---|---|

Operation Modes

| | | | | |
|---|---|---|--|---|
|  |  |  |  |  |
|---|---|---|--|---|

Logo Printing



- ▶ Personalized graphics engraving with laser on obstacles are provided on demand.

Installation Platform



- ▶ Ease of modular installation with anti-skid bottom platform.
- ▶ Front and rear ramp system for easy access.
- ▶ Ease of transportation with forklift unit.

Button Control Unit - Independent



BT - 1



BT - 2

- ▶ BT-1 and BT-2 type options, usually used in security booths or security rooms, for remote control of "In, Out, Emergency" modes.

Access Control Device Adaptation Applications

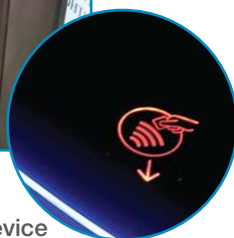

- ▶ Card Pass Readers
- ▶ Finger Print, Biometric Device
- ▶ Barcode Reader

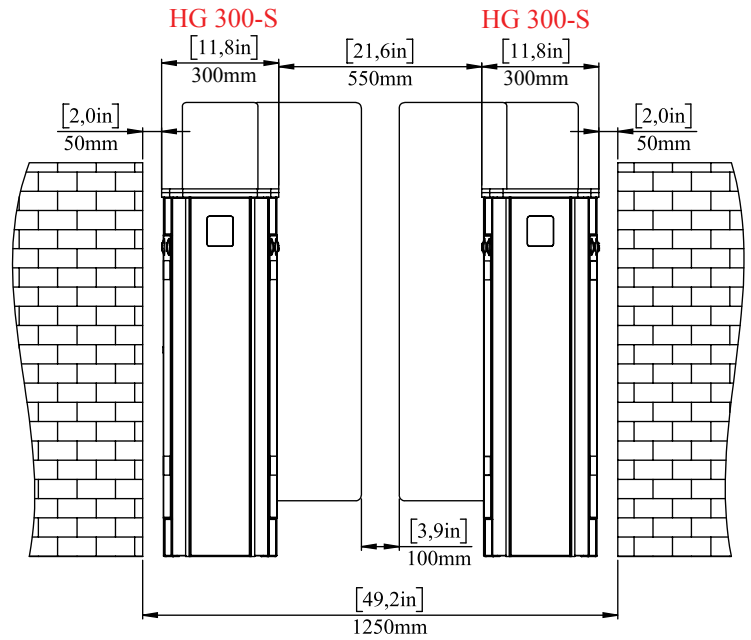
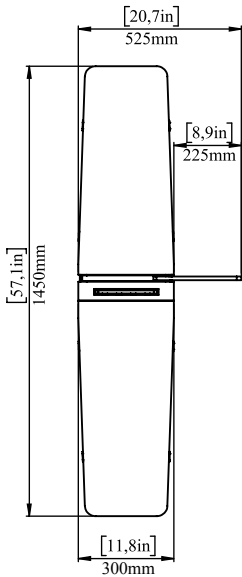
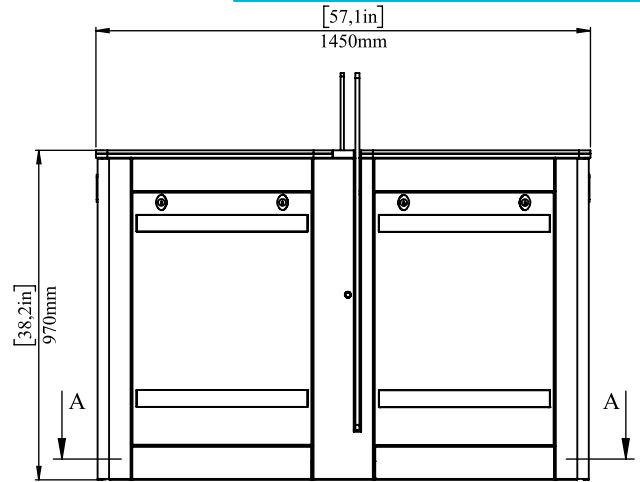
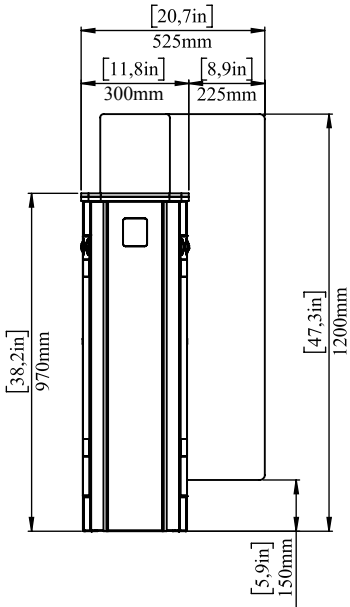

SECTION A-A

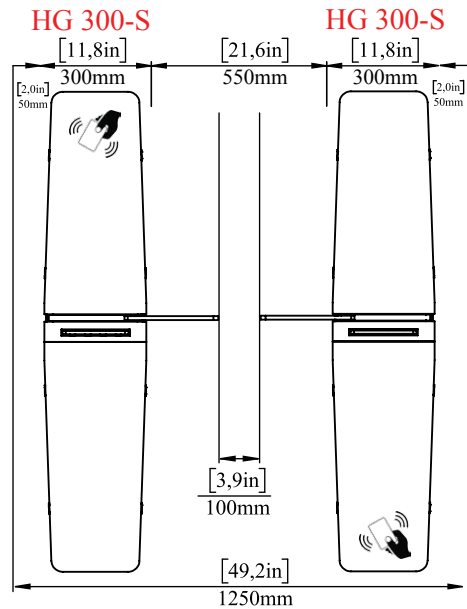
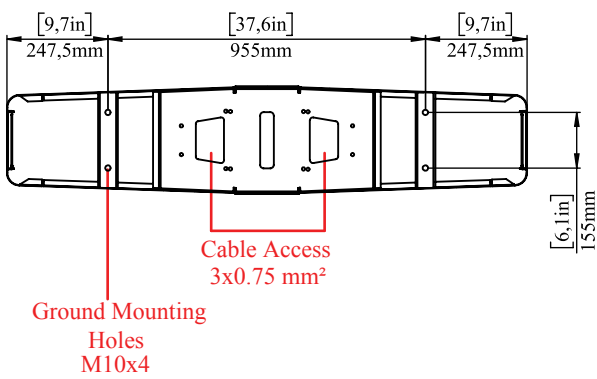

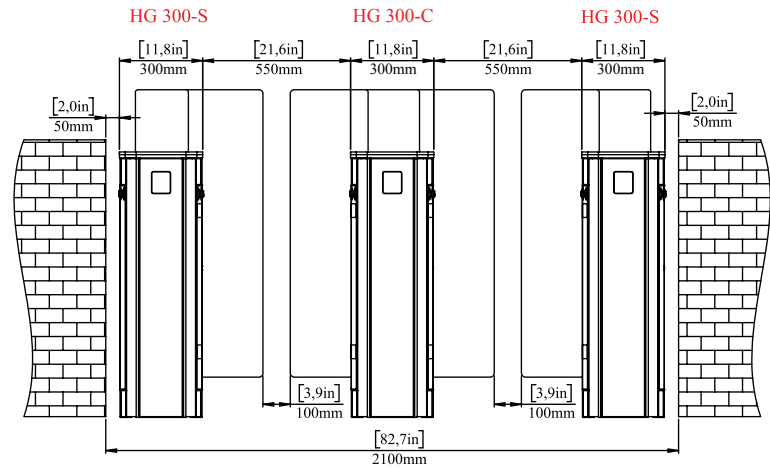
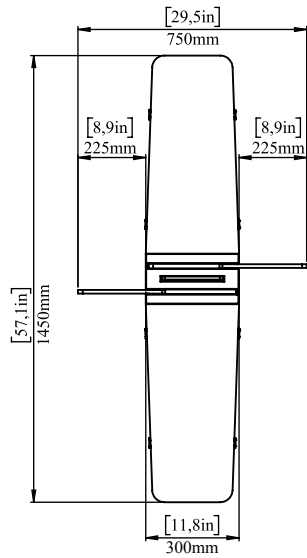
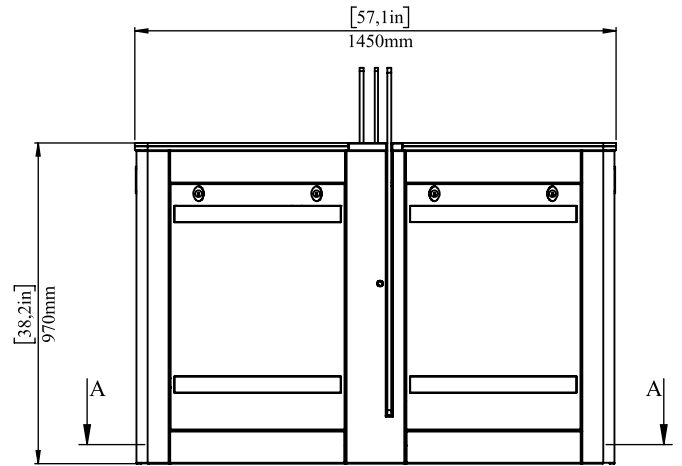
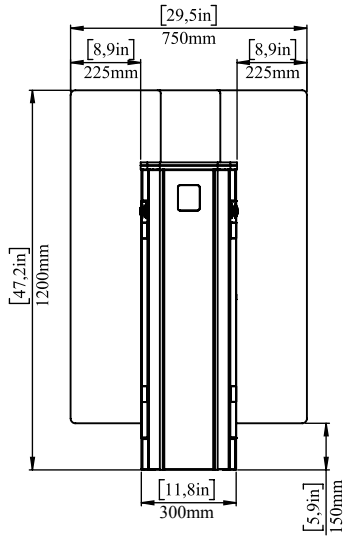

SECTION A-A

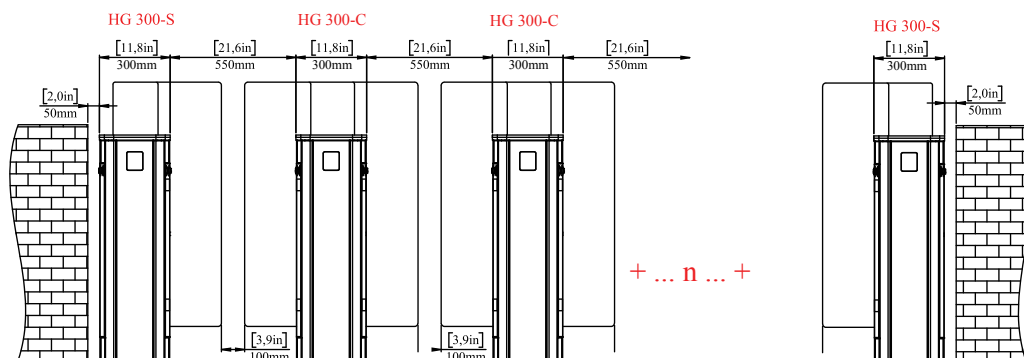
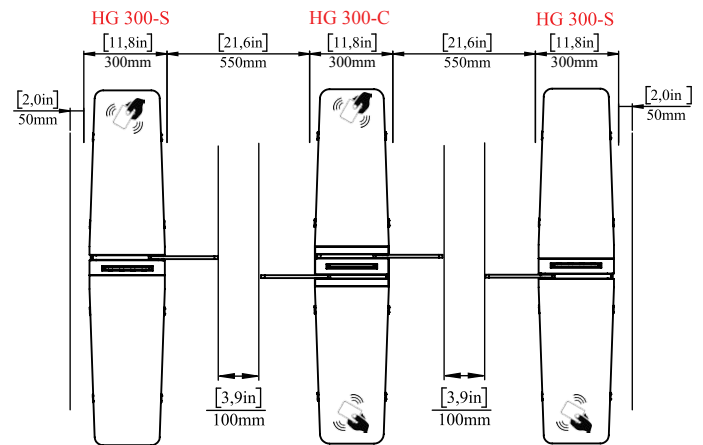
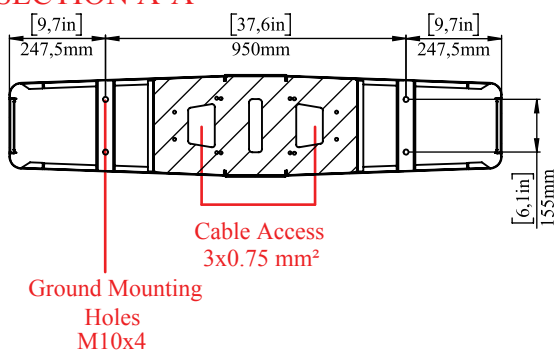

Aktuel®

TURNSTILE

Your Gate to Protection...

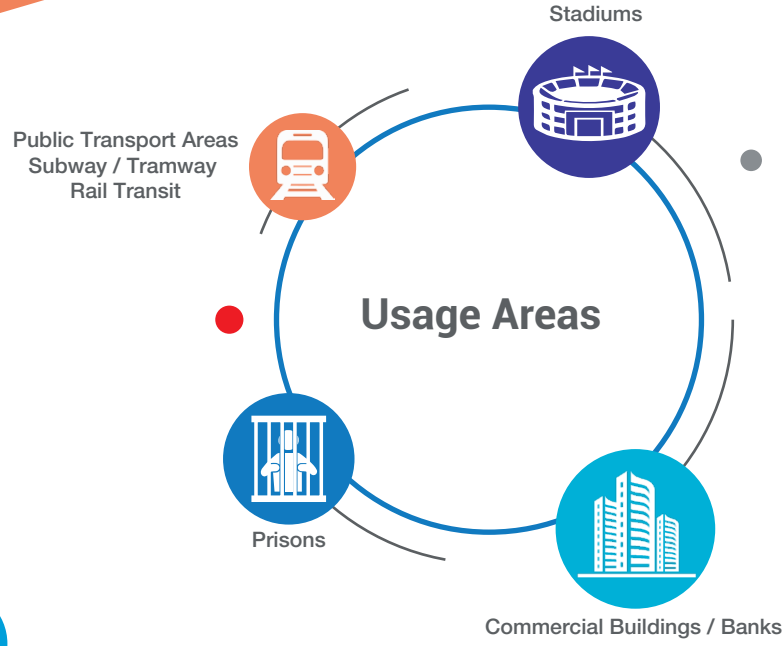

Factory

Ivedik OSB Agac Isleri San. Sit. 1333.Cad. No:25 Ostim - Yenimahalle
ANKARA - TURKEY

+90 312 395 02 88

+90 312 395 02 70

Branch

Perpa Ticaret Merkezi A Blok - Kat:7-8 No:758 Sisli - ISTANBUL - TURKEY

+90 212 320 69 79

+90 212 320 69 79

www.aktuelturnike.com.tr

export@aktuelturnike.com.tr

Local Reseller

| |
|--|
| |
|--|