



## SPEED GATE TURNSTILE

HG - 400 - S | HG - 400 - C  
SERIES

Your gate to protection...

HG-400 Series are durable products that can be used indoors. Provides access and access control in areas requiring moderate security. With its compact design, it provides the perfect solution for assembly areas where aesthetics and elegance are important.

Barrier arm movement is provided by the 400W Servo motor with PLC control. Eight optical sensors in the turnstile provide control of access control scenarios. Speed Gate Turnstiles are suitable for intensive use. It is the perfect solution when architectural design, aesthetics and transition speed are important.

### Design

- ▶ The main body of the turnstile is made of 304 stainless steel and the wings are made of 10 mm tempered glass material.
- ▶ Stain case design with smoothed corner.
- ▶ All other parts in turnstile are electro-galvanized against corrosion.

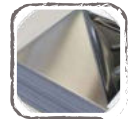

### Safety

- ▶ Obstacle movement of the wings is provided by PLC controlled "400W Servo Motor".
- ▶ Heavy duty mechanics, controlled by reliable electronics ensure a long product life with minimum maintenance requirement.



### Integration

- ▶ Easy integration with all access control equipment through functional electronic control board ( For example: RFID Device, Button Control, Finger Print and Biometric Device )



HG - 400 - S



Single Wing

- ▶ Turnstile main body is 304 stainless steel, wings are tempered glass.
- ▶ The top cover is made of black glass with 10mm tamper.
- ▶ Configured as:
  - \* Master / Starting Unit or
  - \* Slave / Ending Unit
 Provides one 550 mm wide passage together with corresponding standard wing.

HG - 400 - C



Double Wing

- ▶ Turnstile main body is 304 stainless steel, wings are tempered glass.
- ▶ The top cover is made of black glass with 10mm tamper.
- ▶ Configured as:
  - \* Master / Center Unit and
  - \* Slave / Center Unit
 Provides two 550 mm wide passages at each side together with corresponding standard wings



## Technical Specifications

### Main Body





Material	AISI- 304 - Stainless Steel - Scotch Brite	304
Top Cover	10 mm tempered glass ( Upper surface of plexiglass )	
Inner Case	Reinforced with 6 mm horizontal galvanized metal bars to increase strength.	
Wings	10 mm tempered glass ( Opt. Logo Printing )	
Standard Dimensions ( W x L x H )	19 x 140 x 100 cm ( Single Wing ) - 26 x 140 x 100 cm ( Double Wing )	
Standard Passageway Width	550 mm ( Passage Area : 250 mm + 50 mm + 250 mm )	
Wing Height	120 cm to 150 cm	

### Electrical Parameters





















Operating Voltage	110 - 240V AC 50/60 Hz (+/- %10)
Max Current / Power Consumption	5A / 250W
Mean Cycles Between Failure ( MCBF )	15 M Cycles

### Function Working

Control Systems	All inputs are opto-coupler protected. Controlled by dry contact or grounding input. Compatible with all access control systems that provide dry contact or grounding outputs
Output Data (Feedback)	The systems provides dry contact, NO - Normally Open, entry - exit passage feedback by relays
Movement Mechanism	400W Servo Motor
Sensor Control	8 point (pairs) IR sensor control for N/O mode, sequential (switching) passage feature for N/C mode. The system continuously monitors the status of the corridor and gives alarm in several cases.
Electronic Control Unit / Communication	PLC control unit / RS 232 ( Need PC Systems hardware serial port )
Gate Open - Close Rate / Time out Delay	0,5 - 1, 5 second / Adjustable ; Operating Modes
Flow Rate	30 Person - Passage / Minutes / Normally Standard* (*The use of different access control units may result in a change in the transition speed.)
Working Environment - IP Rating	Indoor - IP 44
Operating Temperature / Humidity	-20° C / + 68° C - 0 / + 45° C ( RH 95% not-condensing )
Occupancy Monitoring	When a user occupies the lane without flushing a card, systems gives alarm after an adjustable time.
Anti - Tail - Gating	When an unauthorized access attempt is made right after a valid access, system will give alarm and block access right after the valid passage (alarm/block access configurations are adjustable)
Position Detection	Position of the obstacle wings are continuously detected by servo motor
Side Led Stripes	Passage Free - Green / Passage Closed - Red / Standby - Blue
Passage Direction	Bi-Directional operation feature. Entrance-Exit

Number of Passage Lanes	Single Unit  <input checked="" type="checkbox"/> Double Unit  <input checked="" type="checkbox"/>
Wing Movement	Wings Retracting into Body Linear Movement System  <input checked="" type="checkbox"/> Swing Wing Movement  <input checked="" type="checkbox"/>

### Access Specifications

550 mm	 <input checked="" type="checkbox"/>  <input checked="" type="checkbox"/>  <input checked="" type="checkbox"/>  <input checked="" type="checkbox"/>  <input checked="" type="checkbox"/>  <input checked="" type="checkbox"/>  <input checked="" type="checkbox"/>  <input checked="" type="checkbox"/>  <input checked="" type="checkbox"/>  <input checked="" type="checkbox"/>  <input checked="" type="checkbox"/>  <input checked="" type="checkbox"/>  <input checked="" type="checkbox"/>  <input checked="" type="checkbox"/>  <input checked="" type="checkbox"/>  <input checked="" type="checkbox"/>  <input checked="" type="checkbox"/>  <input checked="" type="checkbox"/>  <input checked="" type="checkbox"/>  <input checked="" type="checkbox"/>
	<input checked="" type="checkbox"/> Passage Available <input checked="" type="checkbox"/> Passage have some Limitations <input checked="" type="checkbox"/> Passage Not Available

**Logo Printing**

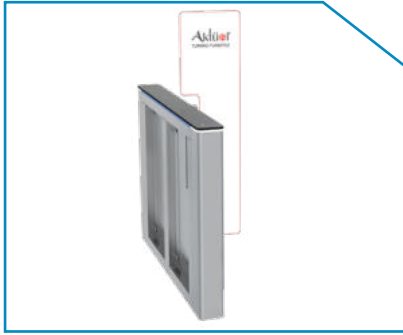

- ▶ Personalized graphics engraving with laser on obstacles are provided on demand.

**Installation Platform**



- ▶ Ease of modular installation with anti-skid bottom platform.
- ▶ Front and rear ramp system for easy access.
- ▶ Ease of transportation with forklift unit.

**Button Control Unit - Independent**



**BT - 1**



**BT - 2**

- ▶ BT-1 and BT-2 type options, usually used in security booths or security rooms, for remote control of "In, Out, Emergency" modes.

**Access Control Device Adaptation Applications**



- ▶ Card Pass Readers
- ▶ Finger Print, Biometric Device
- ▶ Barcode Reader

**Operation Modes**

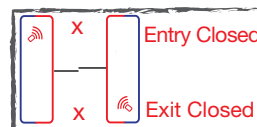
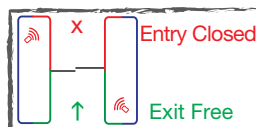
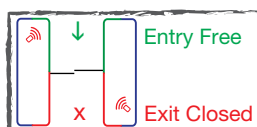
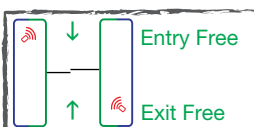

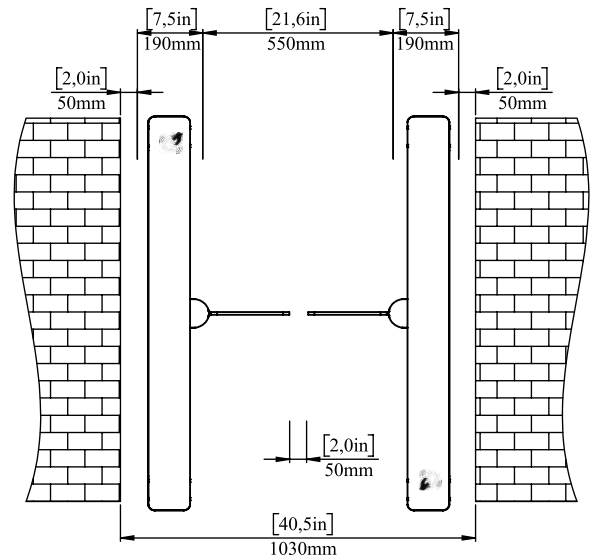
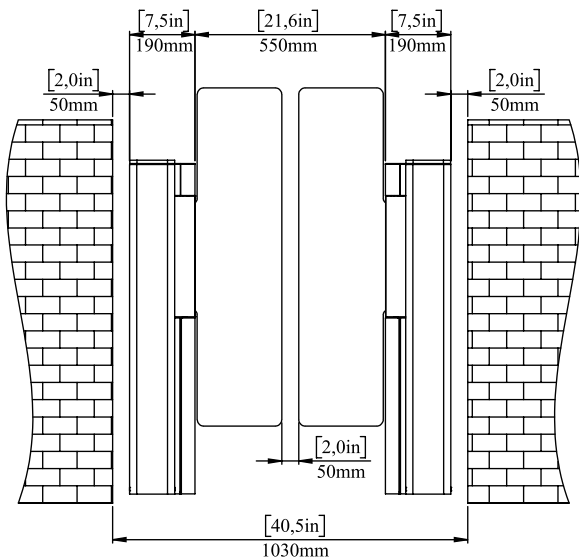
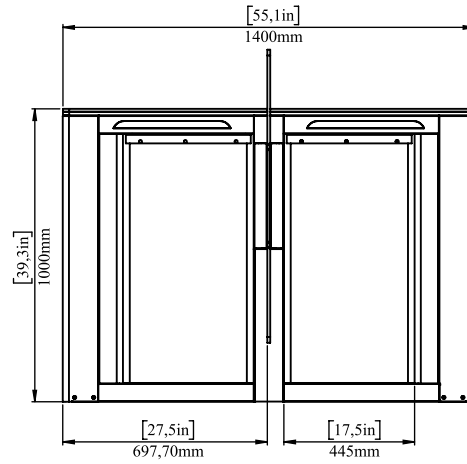
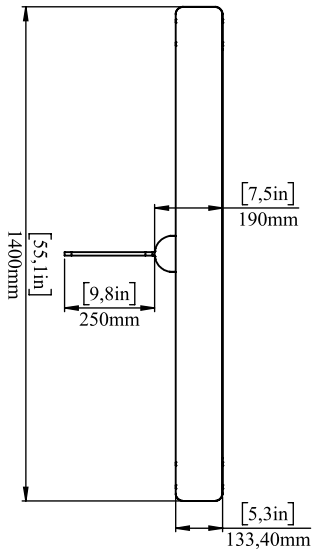
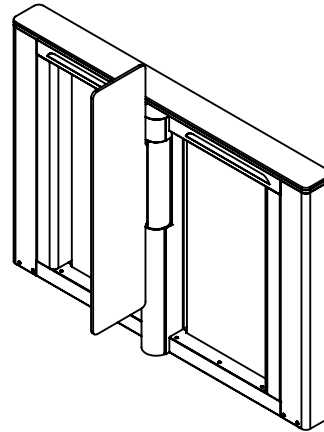
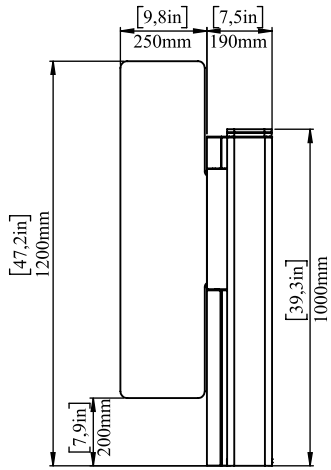

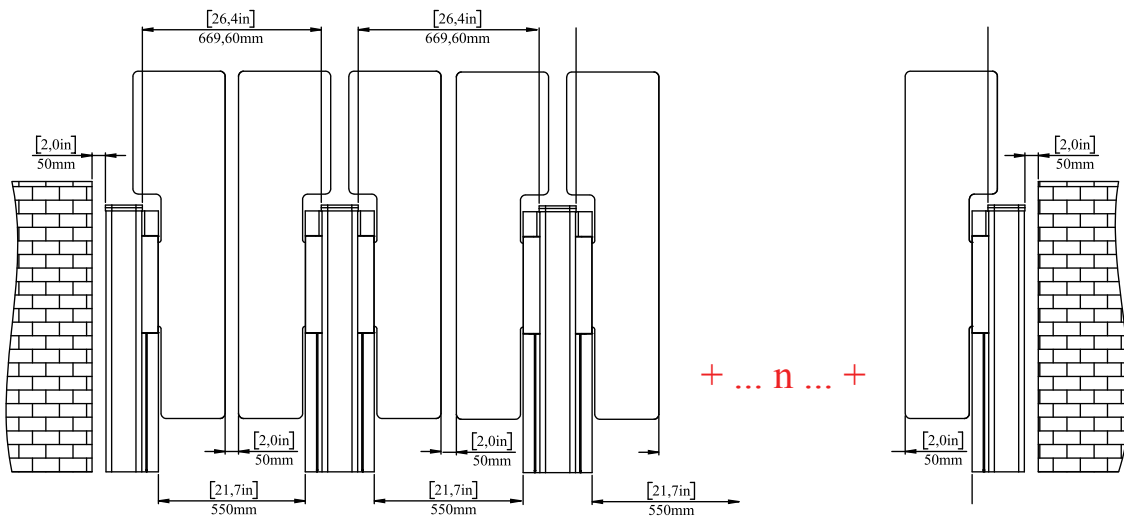
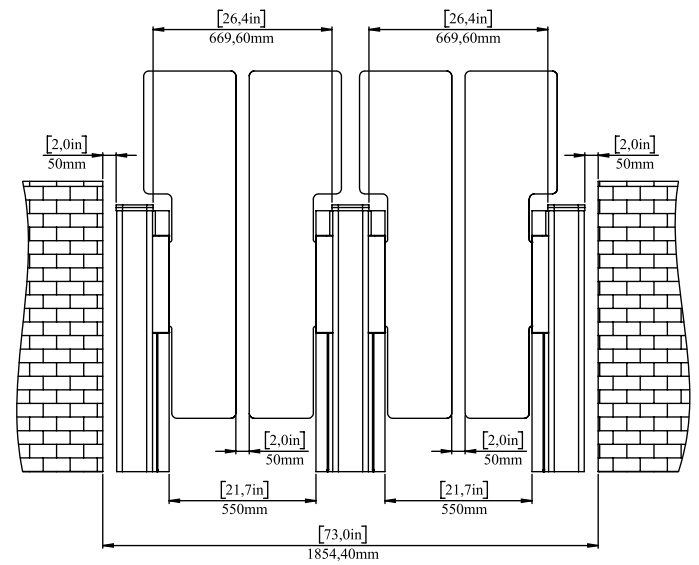
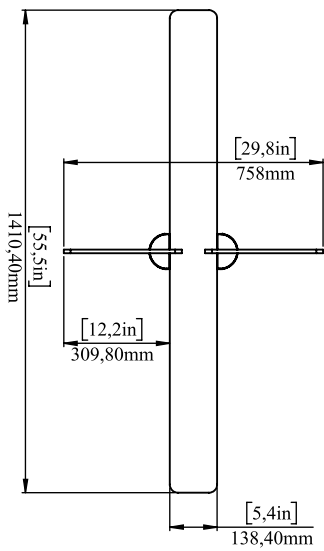
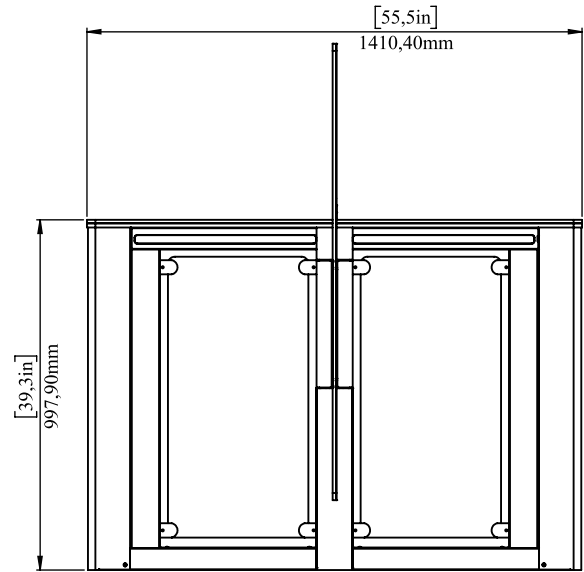
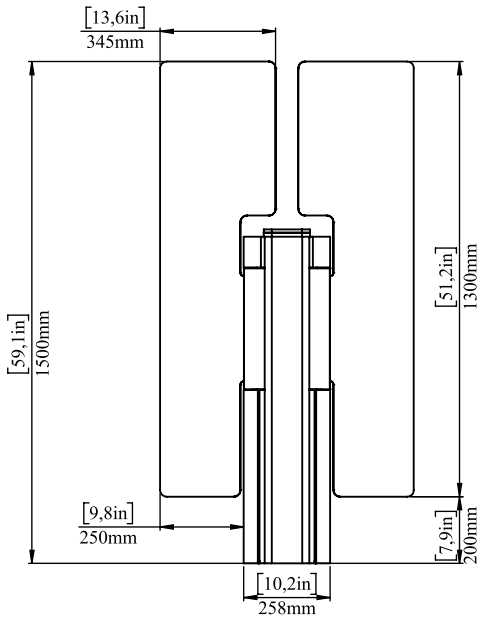

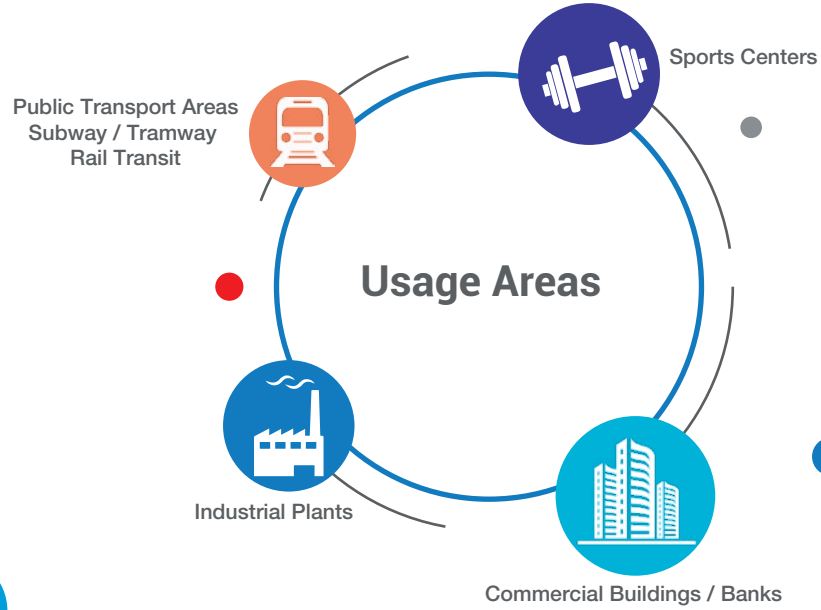

### Factory

Ivedik OSB Agac Isleri San. Sit. 1333.Cad. No:25 Ostim - Yenimahalle  
ANKARA - TURKEY

+90 312 395 02 88

+90 312 395 02 70

### Branch

Perpa Ticaret Merkezi A Blok - Kat:7-8 No:758 Sisli - ISTANBUL - TURKEY

+90 212 320 69 79

+90 212 320 69 79

[www.aktuelturnike.com.tr](http://www.aktuelturnike.com.tr)

[export@aktuelturnike.com.tr](mailto:export@aktuelturnike.com.tr)

### Local Reseller

--