

SECTION A-A

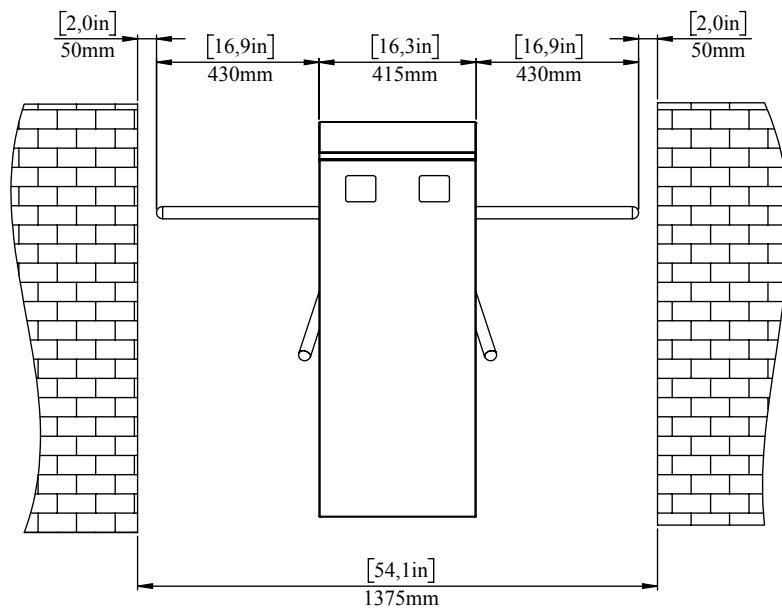
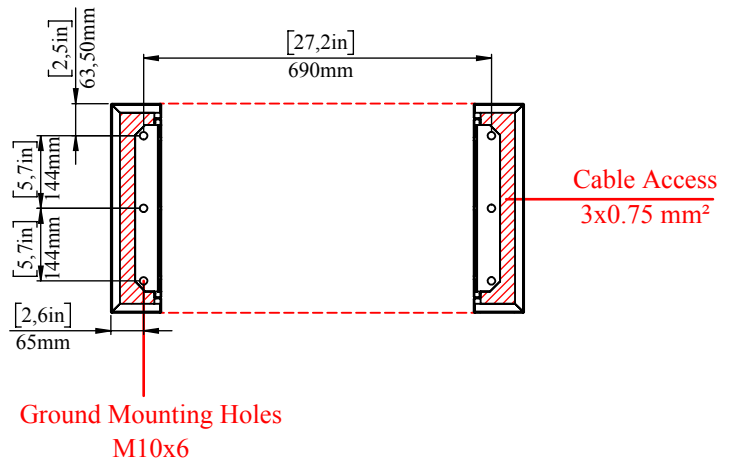

Product Name AKT 60-A Waist Height Double Leg Double Turnstile

Material 304 Quality Stainless Steel

NOTE: Design and measurements can be changed without notice.