



AKT - 40

WAIST HEIGHT TURNSTILE

SINGLE LEG - TOKEN

Your gate to protection...

Waist Height Turnstiles are robust products functioning indoor and provide access control in areas requiring moderate level of security.

With proven ability to handle massive crowds in places like commercial centers, schools, government and private offices or industrial buildings, Waist Height Turnstiles ensure robust solutions for crowd control.

Design

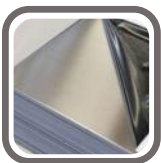

- Turnstile main body and tripod arms are manufactured from 304 grade stainless steel.
- Stain case design with smoothed corner.
- All other parts in turnstile are electro-galvanized against corrosion.

Safety



- Electrical and mechanical safety is provided in the turnstile.
- Heavy duty mechanics, controlled by reliable electronics ensure a long product life with minimum maintenance requirement.

Integration





- Easy integration with all access control equipment through functional electronic control board
(For example: RFID Device, Button Control, Finger Print and Biometric Device)





Main Body

Material	AISI- 304 - Stainless Steel - Scotch Brite (Op. AISI-316 Quality)	304
Tripod Arms	Q32 mm dia - Stainless Steel - Arms can be dismantled or mounted one by one separately	
Rotor Systems	With rotating control; tripod arms are positioned at 120 degrees	
Tripod Hub	Cast aluminium with polished finished	
Rotation Control	Self centering and smooth operation is handled by means of spring and hydraulic damping mechanism	
Standard Dimensions (W x L x H)	28 x 45 x 97 cm	
Standard Passageway Width	480 mm (Arm Length : 430 mm)	









Electrical Parameters

Operating Voltage	110 - 240V AC 50/60 Hz (+/- %10)	
Nominal / Max Current	250Ma / 850 Ma	
Power Consumption	30 W	24V DC
Mean Cycles Between Failure (MCBF)	1M Cycles	



Function Working

Control Systems	All inputs are opto-coupler protected. Controlled by dry contact or grounding input. Compatible with all access control systems that provide dry contact or grounding outputs	
Output Data (Feedback)	The systems provides dry contact, NO - Normally Open, entry - exit passage feedback by relays	
Passage Direction	Bi-Directional operation feature. Entrance-Exit	
Time out Delay	Adjustable ; Operating Modes (7 - 14 - 21 second)	
Flow Rate	30 Passage / Minutes / Normally Standard	
Emergency Mode	System allows free passage in emergency mode and in case of power failure	
Indicators Features	Entrance - Green Arrow / Exit - Red Cross	
Communication	RS 232 (Need PC Systems hardware serial port)	
Operating Temperature	-20° C / + 50° C	
Operating Humidity	0 / + 45° C (RH 95% not-condensing)	
IP Rating	IP - 54	
Working Environment	Indoor	

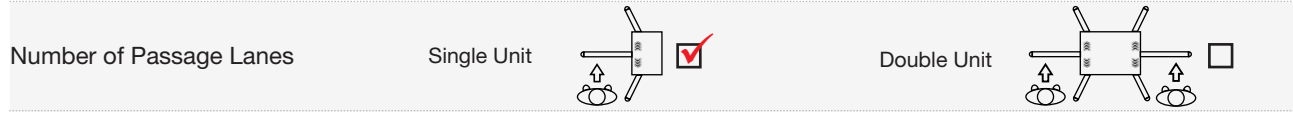

Operation Modes

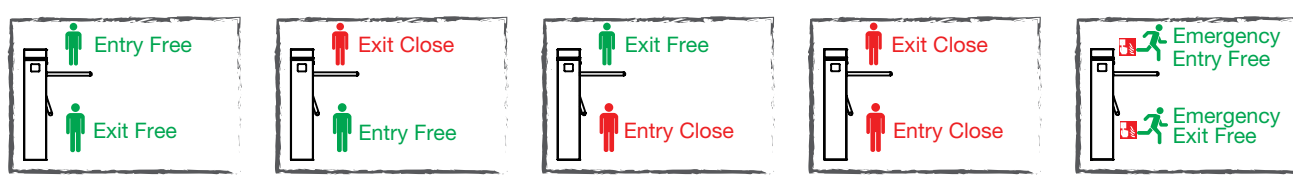

Installation Platform



- ▶ Ease of modular installation with anti-skid bottom platform.
- ▶ Ease of installation in difficult ground conditions.
- ▶ Front and rear ramp system for easy access.

Passage Tracking Sensors



- ▶ Sensors can be deployed on the turnstile in accordance with required functions such as real-time passage signal or unauthorized passage alarm.
- ▶ 2 Sensors for one passage is available for bi-directional operation.

Button Control Unit - Independent



- ▶ Provides remote control of "Entry - Exit - Emergency" modes of security personnel and consultation areas.
- ▶ BT-1 and BT-2 type options.

Receiver Unit / Remote Control



- ▶ 1 Unit, working with 23V type 12V battery.
- ▶ 433.920MHz working frequency.
(Legal ISM band for Turkey and Europe)
- ▶ 2-button, PT2260 code integration;
Maximum output power of 10 mW.

Digital Counter



- ▶ H:24 X W:48 X D:48.5 mm 8-digit segment display is available.
- ▶ To be able to keep the memory of a power failure, be able to count on dry contact and voltage, reset capability.
- ▶ Possibility to reset from front face and reset input;
10 years battery life

Separator



- ▶ The main post and the bottom base to which the intermediate side lath pipes and main posts are connected are made of 304 quality stainless steel.
- ▶ Ability to shorten optional intermediate pipes.
- ▶ Spacebar of the central portion, optionally, glass, plexiglass, to close with dekota types of material properties are available.

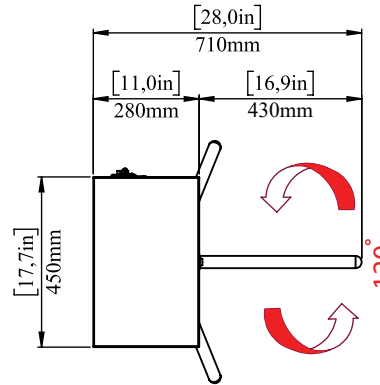
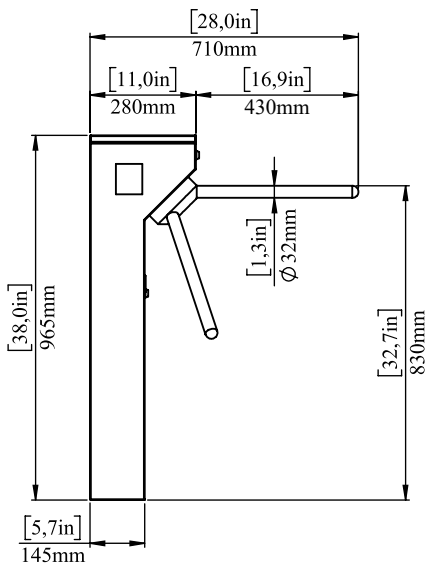
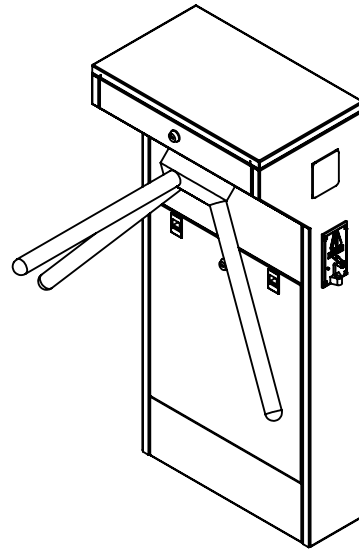
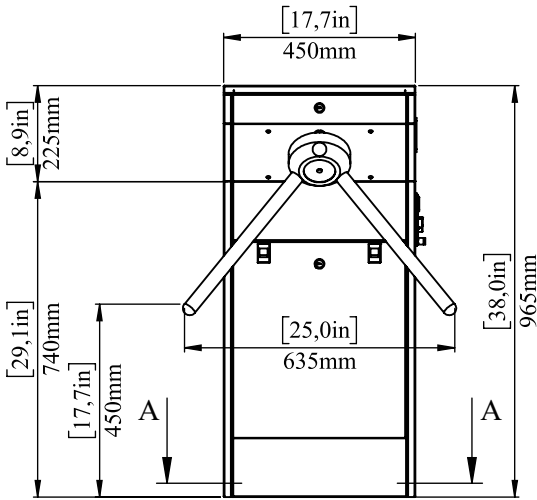

SECTION A-A

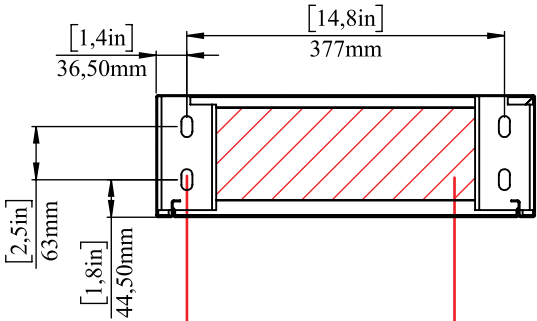

Ground Mounting Holes
M10x4

Cable Access
3x0.75 mm²

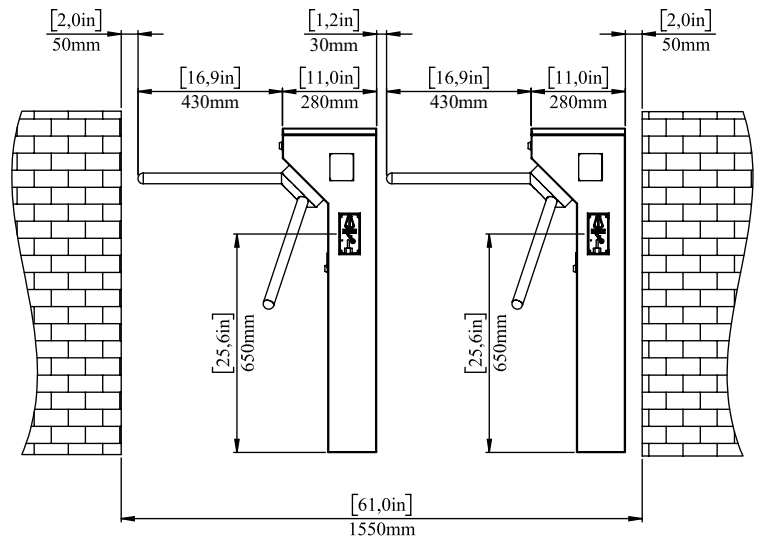

Aktuel®

T U R N S T I L E

Your Gate to Protection...

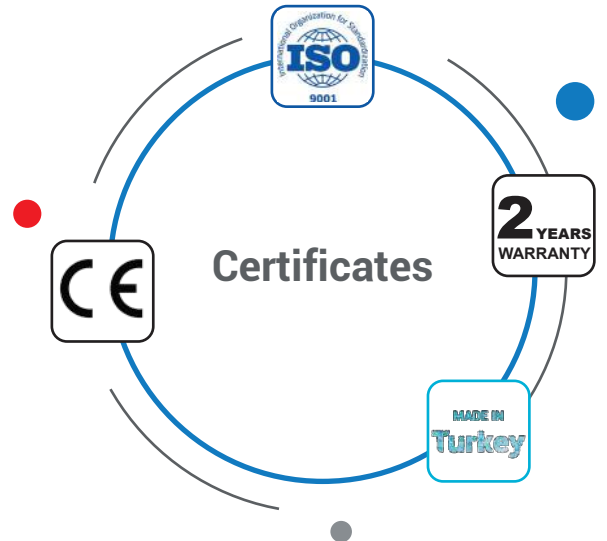
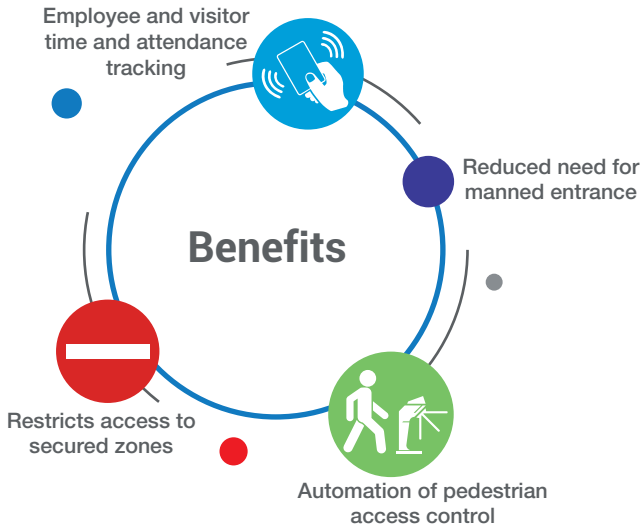
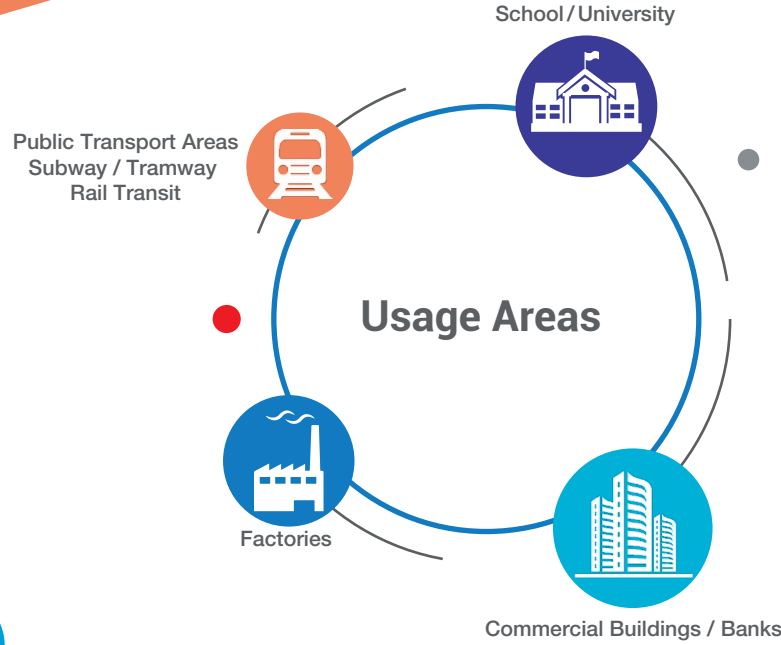

Factory

Ivedik OSB Agac Isleri San. Sit. 1333.Cad. No:25 Ostim - Yenimahalle
ANKARA - TURKEY

+90 312 395 02 88

+90 312 395 02 70

Branch

Perpa Ticaret Merkezi A Blok - Kat:7-8 No:758 Sisli - ISTANBUL - TURKEY

+90 212 320 69 79

+90 212 320 69 79

www.aktuelturnike.com

export@aktuelturnike.com.tr

Local Reseller

--